

ATLAS 12ZR



112 kNm



7,4 bis
9,4 m



3,0 bis
3,6 m



3,7 m



2.060 kg



420°



25,8 kNm



255 bar



1x
80 bis
100 l/min
ca. 46 kW



2x
65 l/min
ca. 60 kW



LS
150 l/min
ca. 70 kW

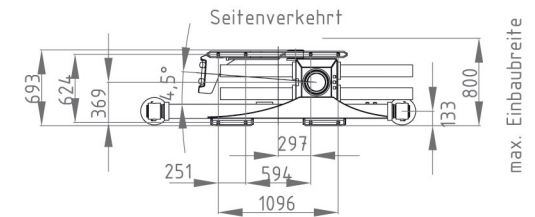
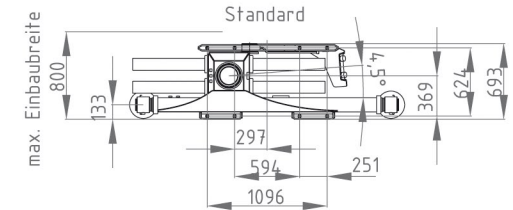
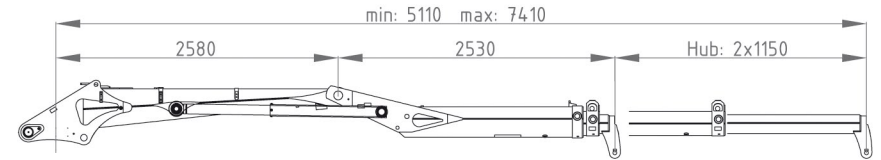
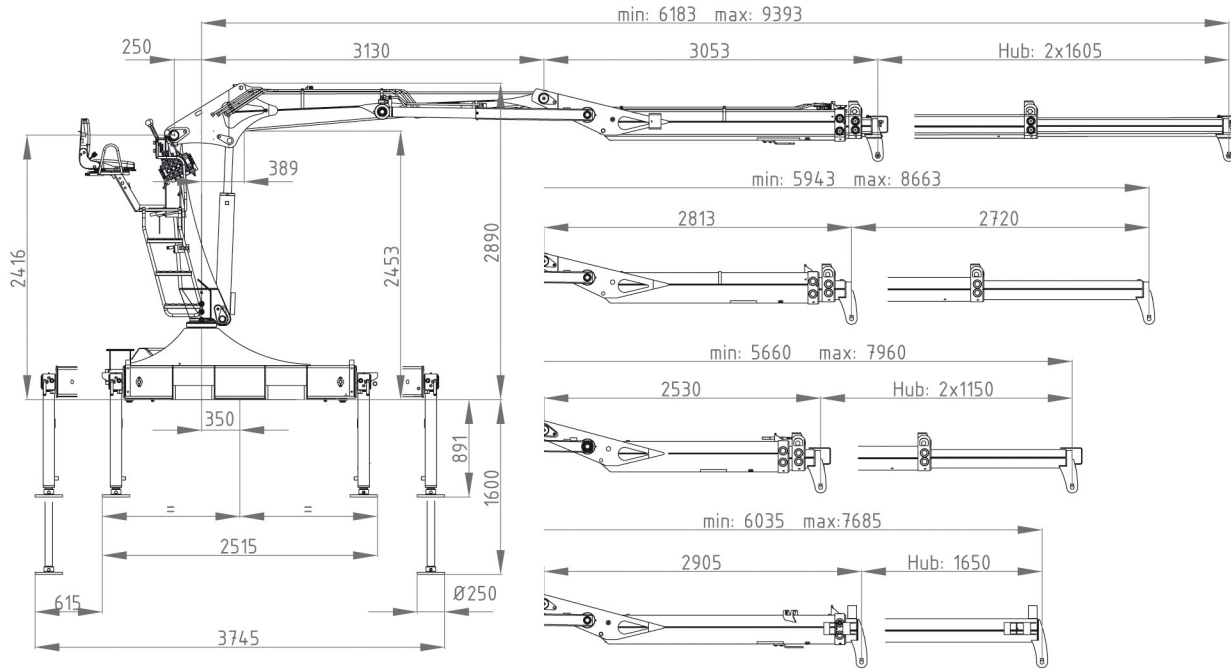

9,4m
Schläuche innen

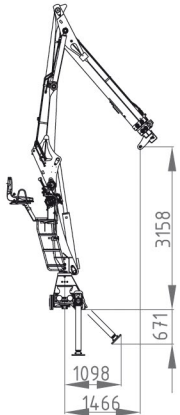

8,65m
Schläuche innen

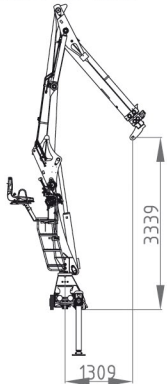

8,0m
Schläuche innen

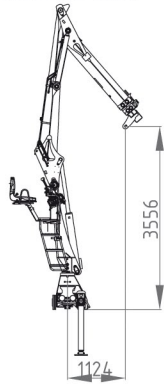

7,7m
Schläuche außen/innen

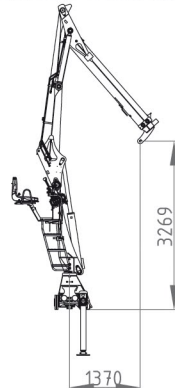

7,4m
Schläuche innen

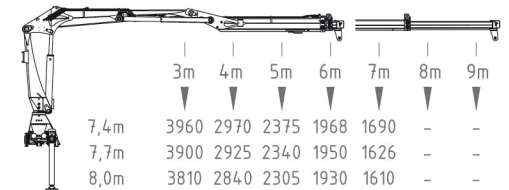
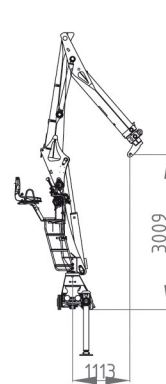

	3m	4m	5m	6m	7m	8m	9m	
7,4m	3960	2970	2375	1968	1690	-	-	kg
7,7m	3900	2925	2340	1950	1626	-	-	kg
8,0m	3810	2840	2305	1930	1610	-	-	kg
8,65m	3715	2783	2230	1895	1580	1405	-	kg
9,4m	3810	2670	2140	1850	1540	1370	1180	kg

